

Capacitance Diaphragm Gauge





Stripe CDG045Dhs



Operating Manual
Incl. EC Declaration of Conformity

Product Identification

In all communications with INFICON, please specify the information given on the product nameplate. For convenient reference copy that information into the space provided below.

INFICON AG, LI-9496 Balzers		  
Model:	
PN:	
SN:	
	V	W

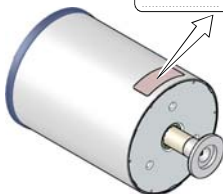

Validity

This document applies to products of the Stripe CDG045Dhs series.

Part numbers of standard products are indicated below. OEM products have other part numbers and different parameter settings (e.g. factory setting of setpoint) as defined in the corresponding ordering information.

3 C C 9 - 6 6 1 - 2 3 8 0

Flange	1	DN 16 ISO-KF
	3	DN 16 CF-R
Unit	9	½" tube
	E	8VCR female
Measurement range (F.S.)	5	Torr (× 133 Pa; × 1.33 mbar)
	6	mbar (× 100 Pa)
Measurement range (F.S.)	S	0.01 (Torr only)
	1	0.02
	2	0.05
	3	0.1
	4	0.25
	5	0.5
	6	1
	7	2
	8	5
	9	10
	A	20
	B	50
	C	100
	D	200
E	500	
F	1000 (Torr only)	
G	1100 (mbar only)	

The part number (PN) can be taken from the product nameplate.

If not indicated otherwise in the legends, the illustrations in this document correspond to gauges with DN 16 ISO-KF vacuum connection. They apply to gauges with other vacuum connections by analogy.

We reserve the right to make technical changes without prior notice.

Intended Use

The temperature compensated Capacitance Diaphragm Gauges of the Stripe CDG045Dhs series are intended for absolute pressure measurement of gases in their respective pressure ranges (→  3).

Ideally the measurement values can be read out digitally via EtherCAT interface or analog. The gauges can also be operated in connection with an INFICON Vacuum Gauge Controller (VGC series) or another appropriate controller.

Functional Principle

A ceramic diaphragm is deflected by pressure. The deflection is measured capacitively and converted into a digital or into an analog linear output signal by the digital electronics. The digital output signal can only be read out via the EthreCAT interface.

The output signal is independent of the gas type.

Very accurate pressure measurement is achieved by heating the sensor to a constant temperature of 45°C which results in a compensation of changes in the ambient conditions and a reduced deposition of process products and by-products in process applications.

Trademarks

SKY® INFICON GmbH
VCR® Swagelok Marketing Co.

Patents

EP 1070239 B1, 1040333 B1

US Patents 6528008, 6591687, 7107855, 7140085



Scope of Delivery

- 1× gauge Stripe CDG045Dhs
- 1× pin for adjusting settings via buttons
- 1× Calibration Test Report
- 1× Operating Manual German
- 1× Operating Manual English

Contents

Product Identification	2
Validity	3
Intended Use	4
Functional Principle	4
Trademarks	4
Patents	5
Scope of Delivery	5
1 Safety	8
1.1 Symbols Used	8
1.2 Personnel Qualifications	8
1.3 General Safety Instructions	9
1.4 Liability and Warranty	9
2 Technical Data	10
3 Installation	16
3.1 Vacuum Connection	16
3.2 Power Connection	19
3.2.1 D-Sub, 15-pin Connector	20
3.2.2 EtherCAT Connector	21
3.2.3 Mini USB Type B Connector (Diagnostic Port)	22
4 Operation	23
4.1 Status Indication	23
4.2 Zeroing the Gauge	24
4.2.1 <ZERO> Adjustment	24
4.3 Switching Functions SP1, SP2	28
4.4 Error Status	32
4.5 ATM Setpoint	33
4.6 Activating the Factory Setting (Factory Reset)	34
4.7 Diagnostic Port (USB Interface)	35
4.8 EtherCAT Operation	36
5 Deinstallation	37
6 Maintenance, Repair	39

7	Returning the Product	39
8	Disposal	40
	Further Information	41
	EC Declaration of Conformity	42

For cross-references within this document, the symbol (→  XY) is used, for cross-references to further documents, listed under "Further Information", the symbol (→  [Z]).

1 Safety

1.1 Symbols Used



DANGER

Information on preventing any kind of physical injury.



WARNING

Information on preventing extensive equipment and environmental damage.



Caution

Information on correct handling or use. Disregard can lead to malfunctions or minor equipment damage.



Notice



Labeling

1.2 Personnel Qualifications



Skilled personnel

All work described in this document may only be carried out by persons who have suitable technical training and the necessary experience or who have been instructed by the end-user of the product.

1.3 General Safety Instructions

- Adhere to the applicable regulations and take the necessary precautions for the process media used.
Consider possible reactions with the product materials.
- Adhere to the applicable regulations and take the necessary precautions for all work you are going to do and consider the safety instructions in this document.
- Before beginning to work, find out whether any vacuum components are contaminated. Adhere to the relevant regulations and take the necessary precautions when handling contaminated parts.

Communicate the safety instructions to all other users.

1.4 Liability and Warranty

INFICON assumes no liability and the warranty becomes null and void if the end-user or third parties

- disregard the information in this document
- use the product in a non-conforming manner
- make any kind of interventions (modifications, alterations etc.) on the product
- use the product with accessories not listed in the product documentation.

The end-user assumes the responsibility in conjunction with the process media used.

Gauge failures due to contamination or wear and tear are not covered by the warranty.



2 Technical Data

Measurement range	→ "Validity"
Precision ¹⁾	
0.01 ... 0.05 F.S.	0.2% of reading
Accuracy ²⁾	
0.1 ... 1100 F.S.	0.15% of reading
Temperature effect on zero	
0.01 ... 0.02 F.S.	0.0100% F.S./ °C
0.05 ... 0.5 F.S.	0.0050% F.S./ °C
1 ... 1100 F.S.	0.0025% F.S./ °C
Temperature effect on span	0.01% of reading / °C
Resolution	0.003% F.S.
Gas type dependence	none
<hr/>	
Output signal analog (measurement signal)	
Measurement range	0 ... +10 V
Voltage range	-5 ... +10.5 V (limited to +10.5 V)
Relationship voltage-pressure	linear
Output impedance	0 Ω (short-circuit proof)
Loaded impedance	>10 kΩ
Step response time ³⁾	
Analog output signal	≤1 ms
Digital output signal (EtherCAT interface)	≤2 ms
<hr/>	
Identification	
Resistance R _{Ident}	13.2 kΩ referenced to sup- ply common
Voltage	≤5 V
<hr/>	

¹⁾ → ISO/WD 15725-1

²⁾ Non-linearity, hysteresis, repeatability at 25 °C ambient operating temperature without temperature effects after operation of 2 h.

³⁾ Increase 10 ... 90 % F.S.R.

Remote Zero Adjust	digital input for zero adjustment (→  24)
External switching contact	30 V (dc) / <5 mA (dc)
Switching functions	setpoints SP1/2, ATM, error status
Setpoint relay	
Setting range	1 ... 99% F.S. (0.1 ... 9.9 V)
Hysteresis ⁴⁾	1% F.S.
Switching characteristics ⁴⁾	Low Trip Point (default)
Relay contact	30 V (dc) / ≤0.5 A (dc) floating (NO)
closed	$p \leq p_{SP}$ (LED lit solid)
open	$p \geq p_{SP}$ (LED off)
Status relay	
Relay contact	30 V (dc) / ≤0.5 A (dc) connected to supply common (pin 5)
closed	measurement mode warning
open	no supply voltage warming up, error
Diagnostic port Cable	Mini USB type B, 5-pin USB cable type A/mini B
EtherCAT interface	
Specification, data format, communication protocol	→  [5], [6]
Data rate	100 Mbps
Note address	explicit device identification
Physical layer	100Base-Tx (IEEE 802.3)

⁴⁾ The hysteresis and the switching characteristics can be programmed via the serial interface or the diagnostic port.

EtherCAT connector	2×RJ45, 8-pin, socket input and output
Cable	8-pin, shielded, Ethernet Patch Cable (CAT5e quality or higher)
Cable length	≤100 m

For further information on the EtherCAT interface →  [3]

Supply



DANGER



The gauge may only be connected to power supplies, instruments or control devices that conform to the requirements of a grounded protective extra-low voltage (PELV). The connection to the gauge has to be fused ⁵⁾.

Supply voltage at the gauge	+14 ... +30 V (dc) or ±15 V (dc)
-----------------------------	----------------------------------

Power consumption while being heated	≤14 W
at operating temperature	≤9 W

Fuse to be connected ⁵⁾	≤1.25 AT
------------------------------------	----------

The gauge is protected against reverse polarity of the supply voltage and overload.

⁵⁾ INFICON controllers fulfill this requirement.

Electrical connection	15-pin D-Sub, male
Sensor cable	15-pin plus shielding
Cable length	
Supply voltage 15 V	≤ 8 m (0.14 mm ² /conductor) ≤15 m (0.25 mm ² /conductor)
Supply voltage 24 V	≤43 m (0.14 mm ² /conductor) ≤75 m (0.25 mm ² /conductor)
Supply voltage 30 V	≤88 m (0.14 mm ² /conductor) ≤135 m (0.25 mm ² /conductor)
For longer cables, larger conductor cross-sections are required ($R_{\text{cable}} \leq 1.0 \Omega$).	
Grounding concept	→ "Power Connection"
Materials exposed to vacuum	ceramics (Al ₂ O ₃ ≥99.5%), stainless steel AISI 316L
Internal volume	≤4.2 cm ³
Admissible pressure (absolute)	
1000 / 1100 F.S.	3 bar
1 ... 500 F.S.	2.6 bar
0.01 ... 0.5 F.S.	1.3 bar
Bursting pressure (absolute)	6 bar
Admissible temperatures	
Storage	-20 °C ... +85 °C
Operation	+10 °C ... +40 °C
Bakeout	≤110 °C at the flange
Relative humidity	≤80% at temperatures ≤+31 °C, decreasing to 50% at +40°C
Use	indoors only, altitude up to 3000 m NN
Degree of protection	IP 30
Mounting orientation	
0.01 ... 0.05 F.S.	standing upright
0.1 ... 1100 F.S.	standing upright to horizontal

Dimensions [mm]

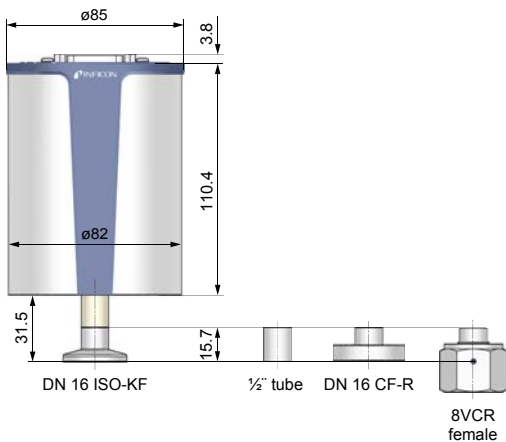

Weight

837 ... 897 g

Analog Measurement Signal vs. Pressure

Pressure p

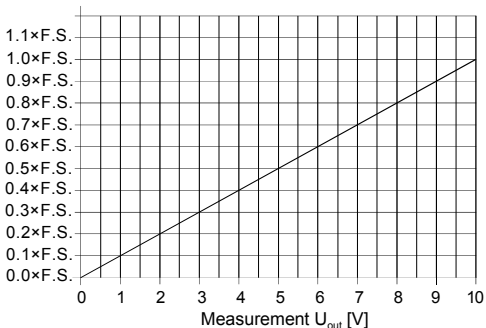

$$p = (U_{\text{out}} / 10 \text{ V}) \times p (\text{F.S.})$$

Conversion Torr \leftrightarrow Pascal

	Torr	mbar ⁶⁾	Pa ⁴⁾
c	1.00	$1013.25 / 760 =$ 1.3332...	$101325 / 760 =$ 133.3224...

Example: Gauge with 10 Torr F.S.
Measurement signal $U_{\text{out}} = 6 \text{ V}$

$$p = (6 \text{ V} / 10 \text{ V}) \times 10 \text{ Torr}$$

$$= 0.6 \times 10 \text{ Torr} = \mathbf{6 \text{ Torr}}$$

⁶⁾ Source: NPL (National Physical Laboratory)
Guide to the Measurement of Pressure and Vacuum, ISBN 0904457x / 1998

3 Installation



WARNING



WARNING: fragile components

The ceramic sensor may be damaged by impacts.

Do not drop the product and prevent shocks and impacts.

3.1 Vacuum Connection



DANGER



DANGER: overpressure in the vacuum system
>1 bar

Injury caused by released parts and harm caused by escaping process gases can result if clamps are opened while the vacuum system is pressurized.

Do not open any clamps while the vacuum system is pressurized. Use the type clamps which are suited to overpressure.



DANGER



DANGER: overpressure in the vacuum system
>2.5 bar

KF flange connections with elastomer seals (e.g. O-rings) cannot withstand such pressures. Process media can thus leak and possibly damage your health.

Use O-rings provided with an outer centering ring.

DANGER

DANGER: protective ground

Products that are not correctly connected to ground can be extremely hazardous in the event of a fault.

Electrically connect the gauge to the grounded vacuum chamber. This connection must conform to the requirements of a protective connection according to EN 61010:

- CF and VCR flanges fulfill this requirement.
- For gauges with a KF flange, use a conductive metallic clamping ring.
- For gauges with a 1/2" tube, take appropriate measures to fulfill this requirement.

Caution

Caution: vacuum component

Dirt and damages impair the function of the vacuum component.

When handling vacuum components, take appropriate measures to ensure cleanliness and prevent damages.

Caution

Caution: dirt sensitive area

Touching the product or parts thereof with bare hands increases the desorption rate.

Always wear clean, lint-free gloves and use clean tools when working in this area.



Mount the gauge so that no vibrations occur.

Mounting orientation

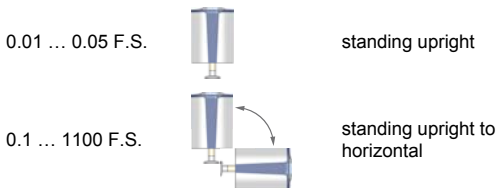

If adjustment should be possible after the gauge has been installed, be sure to install it so that the buttons can be accessed with a pin.

Remove the protective lid and connect the product to the vacuum system.

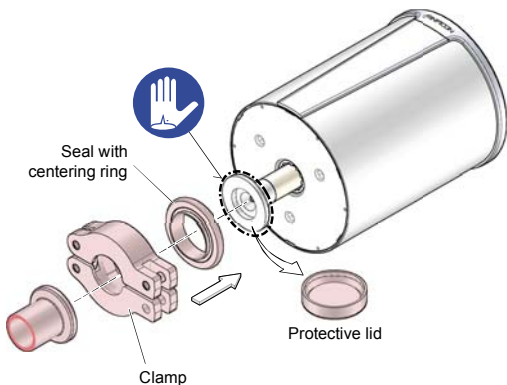



Keep the protective lid.

3.2 Power Connection



Make sure the vacuum connection is properly made (→  16).

DANGER



The gauge may only be connected to power supplies, instruments or control devices that conform to the requirements of a grounded protective extra-low voltage (PELV) The connection to the gauge has to be fused ⁷⁾.



Ground loops, differences of potential, or EMC problems may affect the measurement signal. For optimum signal quality, please do observe the following notes:

- Use an overall metal braided shielded cable. The connector must have a metal case.
- Connect the cable shield to ground at one side via the connector case. Make sure the connector case has direct contact to the cable's shield on its whole circumference. Do not connect the other side of the shield.
- Connect the supply common with protective ground directly at the power.
- Use differential measurement input (signal common and supply common conducted separately).
- Potential difference between supply common and housing ≤ 18 V (overvoltage protection).

⁷⁾ INFICON controllers fulfill this requirement.

3.2.1 D-Sub, 15-pin Connector

If no sensor cable is available, make one according to the following diagram (cable length and conductor cross-sections → 13).

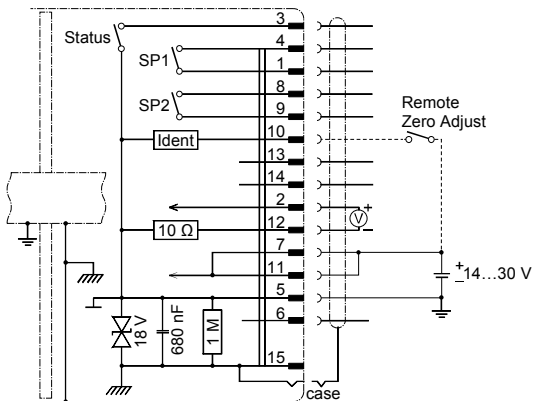

Electrical connection

Pin 1, 4	Relay SP1, closing contact
Pin 2	Signal output (measuring signal) or thresholds SP1/2
Pin 3	Status
Pin 5	Supply common
Pin 7, 11	Supply (+14...+30 V)
Pin 8, 9	Relay SP2, closing contact
Pin 10	Gauge identification or Remote Zero Adjust
Pin 12	Signal common
Pin 15	Housing (Chassis Ground)
Case	Connector case
Pin 6, 13, 14:	NC

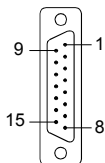

D-Sub, 15-pin female soldering side

3.2.2 EtherCAT Connector



EtherCAT is a communications interface. It is powered via the sensor cable.

If no EtherCAT cables are available, make them according to the following diagram. Connect the EtherCAT cables.



FCC68, 8-pin, soldering side

Pin 1	TD+	Transmission data +
Pin 2	TD-	Transmission data -
Pin 3	RD+	Receive data +
Pin 6	RD-	Receive data -
Pin 4, 5, 7 and 8: NC		

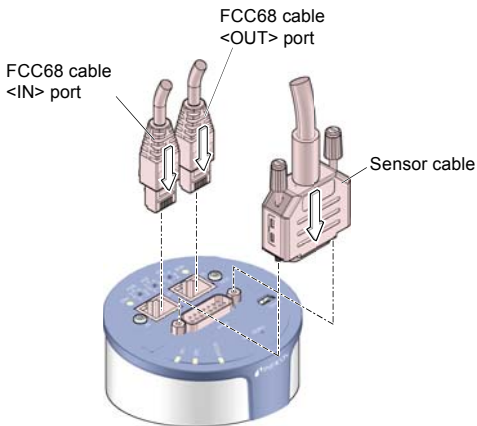

3.2.3 Mini USB Type B Connector (Diagnostic Port)

A standard USB cable can be used. If no cable is available, make one according to the following diagram. Connect the cable.



Mini USB typ B, soldering side

Pin 1	VBUS (5 V)
Pin 2	D-
Pin 3	D+
Pin 4	ID
Pin 5	GND

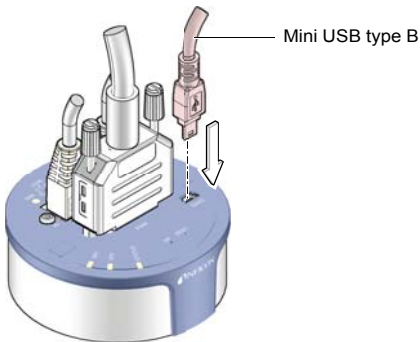

4 Operation

Put the gauge into operation. If you are using an INFICON controller, define the measurement range (→  [1], [2]).

A warm-up time of at least ½ hour should be allowed; for precise pressure measurements a warm-up time of at least 2 hours is required.

4.1 Status Indication

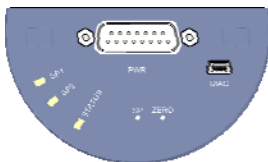

LED	LED status	Meaning
<STATUS>	off	no supply voltage
	lit solid green	measurement mode
	blinking green	warning, over/underrange
	short blinks long blinks	warming up
<SP1>	lit solid red	error
	lit green green	$p \leq$ setpoint 1
	blinking green	waiting for setpoint 1 input
<SP2>	off	$p >$ setpoint 1
	lit solid green	$p \leq$ setpoint 2
	blinking green	waiting for setpoint 2 input
	off	$p >$ setpoint 2

EtherCAT LEDs →  [3]

4.2 Zeroing the Gauge

The gauge is factory calibrated while "standing upright" (→ "Calibration Test Report").

 Perform a zero adjustment, when the gauge is operated for the first time.

Due to long time operation or contamination, a zero drift could occur and zero adjustment may become necessary.

For adjusting the zero, operate the gauge under the same constant ambient conditions and in the same mounting orientation as normally.



The output signal (measuring signal) is depending on the mounting orientation. The signal difference between the vertical and horizontal mounting orientation is:

F.S.	$\Delta U / 90^\circ$
1000 Torr/mbar	$\approx 2 \text{ mV}$
100 Torr/mbar	$\approx 10 \text{ mV}$
10 Torr/mbar	$\approx 50 \text{ mV}$
1 Torr/mbar	$\approx 300 \text{ mV}$
0.1 Torr/mbar	$\approx 1.8 \text{ V}$
$\leq 0.05 \text{ Torr/mbar}$	only standing upright mounting orientation

 If the gauge is operated via a controller, the zero of the whole measuring system has to be adjusted on the controller: first, adjust the zero of the gauge and then, the zero of the controller.

4.2.1 <ZERO> Adjustment

 The zero can be adjusted via

- the <ZERO> button on the gauge,
- the diagnostic port (→  [4]),
- the EtherCAT interface (→  [3]),

- the digital input "Remote Zero" (briefly apply the supply voltage to pin 10),
- an INFICON Vacuum Gauge Controller (VGC series).



While the gauge is being heated and/or under atmospheric pressure, the zeroing function is locked in order for operating errors to be prevented.

- 1 Evacuate the gauge to a pressure according to the table below:

F.S.	Recommended final pressure for zero adjustment		
1100 mbar	-	$<6.65 \times 10^0$ Pa	$<6.65 \times 10^{-2}$ mbar
1000 Torr	$<5 \times 10^{-2}$ Torr	$<6.65 \times 10^0$ Pa	-
500 Torr/mbar	$<2.5 \times 10^{-2}$ Torr	$<3.33 \times 10^0$ Pa	$<3.33 \times 10^{-2}$ mbar
200 Torr/mbar	$<10^{-2}$ Torr	$<1.33 \times 10^0$ Pa	$<1.33 \times 10^{-2}$ mbar
100 Torr/mbar	$<5 \times 10^{-3}$ Torr	$<6.65 \times 10^{-1}$ Pa	$<6.65 \times 10^{-3}$ mbar
50 Torr/mbar	$<2.5 \times 10^{-3}$ Torr	$<3.33 \times 10^{-1}$ Pa	$<3.33 \times 10^{-3}$ mbar
20 Torr/mbar	$<10^{-3}$ Torr	$<1.33 \times 10^{-1}$ Pa	$<1.33 \times 10^{-3}$ mbar
10 Torr/mbar	$<5 \times 10^{-4}$ Torr	$<6.65 \times 10^{-2}$ Pa	$<6.65 \times 10^{-4}$ mbar
5 Torr/mbar	$<2.5 \times 10^{-4}$ Torr	$<3.33 \times 10^{-2}$ Pa	$<3.33 \times 10^{-4}$ mbar
2 Torr/mbar	$<10^{-4}$ Torr	$<1.33 \times 10^{-2}$ Pa	$<1.33 \times 10^{-4}$ mbar
1 Torr/mbar	$<5 \times 10^{-5}$ Torr	$<6.65 \times 10^{-3}$ Pa	$<6.65 \times 10^{-5}$ mbar
0.5 Torr/mbar	$<2.5 \times 10^{-5}$ Torr	$<3.33 \times 10^{-3}$ Pa	$<3.33 \times 10^{-5}$ mbar
0.25 Torr/mbar	$<10^{-5}$ Torr	$<1.33 \times 10^{-3}$ Pa	$<1.33 \times 10^{-5}$ mbar
0.1 Torr/mbar	$<5 \times 10^{-6}$ Torr	$<6.65 \times 10^{-4}$ Pa	$<6.65 \times 10^{-6}$ mbar
0.05 Torr/mbar	$<2.5 \times 10^{-6}$ Torr	$<3.33 \times 10^{-4}$ Pa	$<3.33 \times 10^{-6}$ mbar
0.02 Torr/mbar	$<10^{-6}$ Torr	$<1.33 \times 10^{-4}$ Pa	$<1.33 \times 10^{-6}$ mbar
0.01 Torr	$<5 \times 10^{-7}$ Torr	$<6.65 \times 10^{-5}$ Pa	-

If the final pressure is too high for zero adjustment ($>25\%$ of the F.S.), the zero cannot be reached and the <STATUS> LED blinks green. If this is the case, activate the factory setting and adjust the zero again (\rightarrow 34).

- 2 Operate the gauge for at least 2 hours (until the signal is stable).

- 3** Briefly press the <ZERO> button with a pin (max. $\varnothing 1.1$ mm). The zero adjustment runs automatically. The <STATUS> LED blinks until the adjustment (duration ≤ 8 s) is completed.

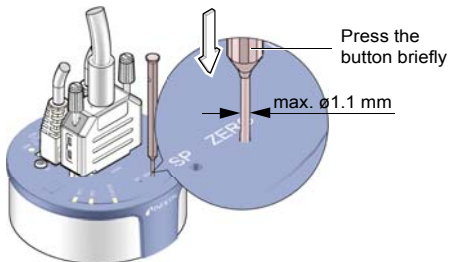

-  After zero adjustment, the gauge automatically returns to the measurement mode.

The <STATUS> LED blinks green if

- the signal output is negative (< -20 mV) when the final pressure has been attained
- the zero adjustment has failed.

4.2.2 <ZERO> Adjustment with Ramp Function



The ramp function allows to adjust the pressure value at a known reference pressure within the measurement range of the gauge.



It also permits to adjust an offset of the characteristic curve in order to

- compensate for the offset of the measuring system or
- obtain a slightly positive zero for a 0 ... 10 V AD converter.

The offset should not exceed 5% of the F.S. (+500 mV). At a higher positive offset, the upper limit of the measurement range is exceeded.

 Zero adjustment using the ramp function can be performed via

- the <ZERO> button on the gauge,
- the EtherCAT interface (→  [3]),
- the diagnostic port (→  [4]),

 Recommended procedure for adjusting the offset of a measuring system: → Notice  24.

- 1** Operate the gauge for at least 2 hours (until the signal is stable).
- 2** Push the <ZERO> button with a pin (max. $\varnothing 1.1$ mm) and keep it depressed. The <STATUS> LED starts blinking. After 5 s, the zero adjustment value, starting at the current output value, keeps continually changing (ramp) until the button is released or until the setting limit (max. 25% F.S.) is reached. The corresponding output signal is delayed by about 1 s.

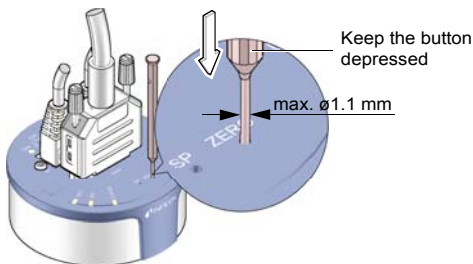

- 3** Push the <ZERO> button again:

Fine adjustment within 0...3 s:	the zero adjustment value changes by one unit (push <ZERO> button in intervals of 1 s)
Change of direction within 3...5 s:	the zero adjustment changes its direction (the blinking frequency of the <STATUS> LED changes briefly)





If the <ZERO> button is released for more than 5 s, the gauge returns to the measurement mode.

The <STATUS> LED blinks green if the signal output is negative (< -20 mV).

4.3 Switching Functions SP1, SP2



The two switching functions can be set to any pressure within the measurement range of the gauge. A solid state relay is provided for each switching function.

The current threshold setting

- is output at the measurement signal output instead of the pressure signal and can be measured with a voltmeter after the <SP1> or <SP2> button is pressed
- can be read / written via the diagnostic port (→  [4]) and the EtherCAT interface (→  [3]).

Switching characteristics and hysteresis



The switching characteristics and the hysteresis of each set point can only be programmed via the diagnostic port (→  [4]) and the EtherCAT interface (→  [3]).

Low Trip Point (default)

If the pressure in the vacuum system is lower than the setpoint, the corresponding LED (<SP1> or <SP2>) is lit solid and the corresponding relay is closed.

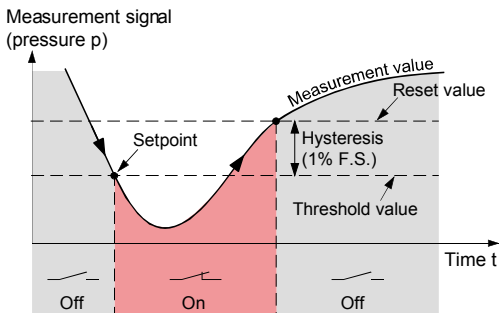

High Trip Point

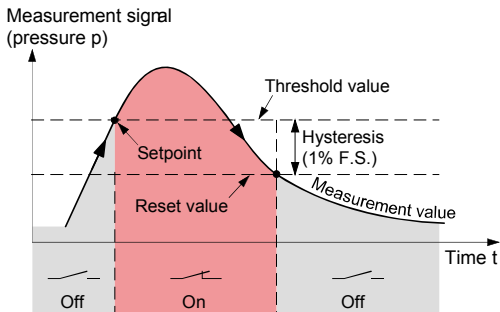

If the pressure in the vacuum system is higher than the setpoint, the corresponding LED (<SP1> or <SP2>) is lit solid and the corresponding relay is closed.





4.3.1 Adjusting the Setpoints SP1, SP2



The thresholds of the setpoints can be adjusted via

- the buttons on the gauge
- the diagnostic port (→  [4])
- the EtherCAT interface (→  [3]).

DANGER





DANGER: malfunction

If processes are controlled via the signal output, keep in mind that by pushing an <SP> button the measurement signal is suppressed and the corresponding threshold value is output instead. This can cause malfunctions.

Push the <SP> button only if you are sure that no malfunction will cause.



The setpoints can be adjusted via

- the buttons on the gauge,
- the diagnostic port (→  [4])
- the EtherCAT interface (→  [3]).

Adjusting Setpoint <1>



Push the <SP> button with a pin (max. $\varnothing 1.1$ mm). The gauge changes to the switching function mode and outputs the current threshold value at the measurement value output for about 10 s (LED <1> blinks).

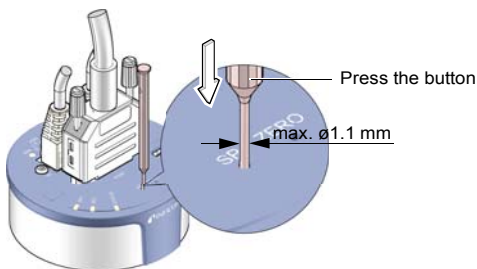

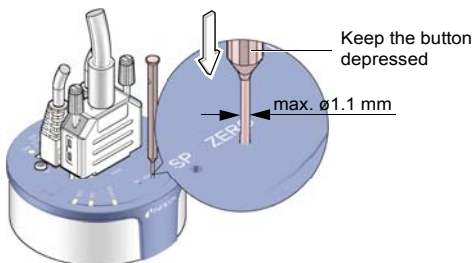

- 2** For changing the threshold value, push the <ZERO> button and keep it depressed. The threshold keeps changing from the current value (ramp) until the button is released or until the limit of the setting range is reached.



- 3** Push the <ZERO> button again:

Fine adjustment within 0...3 s:	the zero adjustment value changes by one unit
Change of direction within 3...5 s:	the zero adjustment changes its direction (the blinking frequency of the <STATUS> LED changes briefly)

-  If the <ZERO> button is released for more than 5 s, the gauge returns the measurement mode.
-  The factory setting of the reset value is 1% F.S. above the Low Trip Point and 1% F.S. below the High Trip Point (hysteresis).
-  If after programming of the hysteresis the button <SP> is pushed, the factory setting of the hysteresis (1%) is reactivated.

Programming setpoint SP1

Programmable parameters:	Low Trip Point
(→  [3], [4])	Low Trip Enable
	Low Trip Point Hysteresis
	High Trip Point
	High Trip Enable
	High Trip Point Hysteresis
	Setpoint Mode

Adjusting setpoint SP2

The adjustment procedure is the same as for setpoint SP1.

4.4 Error Status

The setpoints SP1 and SP2 can be programmed to error status via the diagnostic port or the EtherCAT interface.

4.5 ATM Setpoint

The setpoints SP1 and SP2 of gauges with separate atmospheric pressure sensor⁸⁾ can be programmed to atmospheric pressure setpoint (ATM setpoint) via the diagnostic port or the EtherCAT interface.

The ATM setpoint is defined as a factor of the current atmospheric pressure. The relay switches when the pressure in the vacuum system has reached the defined value (differential pressure in relation to the atmospheric pressure).

Example: ATM setpoint: 110% of the atmospheric pressure
 (= factor 1.1)
 Switching characteristic: High Trip Point
 Hysteresis: 10 mbar

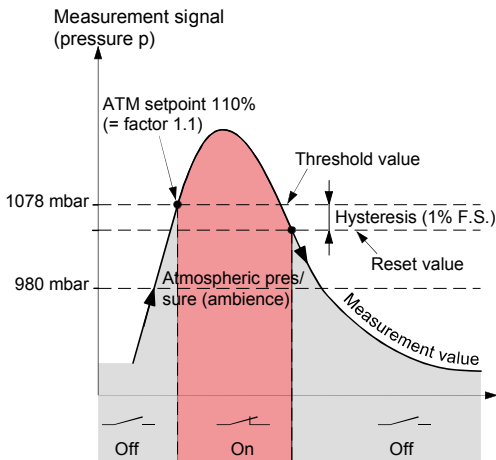

⁸⁾ The atmospheric pressure sensor measures the atmospheric pressure (pressure outside the vacuum system and can be calibrated against the diaphragm capacitive sensor in the gauge (→ **Fehler! Textmarke nicht definiert.**).

The current ATM threshold setting

- can be read / written via the diagnostic port
- is output at the measurement signal output instead of the pressure signal, can be measured with a voltmeter, and is displayed on the LCD display after the <SP1> or <SP2> button is pressed
- can be read / written via the EtherCAT interface.

DANGER



DANGER: malfunction

If processes are controlled via the signal output, keep in mind that by pushing the <SP> button the measurement signal is suppressed and the corresponding threshold value is output instead. This can cause malfunctions.

Push the <SP> button only if you are sure that no malfunction will cause.

Programming ATM setpoint

Programmable parameters: Factor of ATM
 (→  [3], [4]) Low Trip Enable
 Low Trip Point Hysteresis
 High Trip Enable
 High Trip Point Hysteresis
 Setpoint Mode

Switching characteristics of the setpoints →  28.

Diagnostic port →  [4].

4.6 Activating the Factory Setting (Factory Reset)

All user defined parameters (e.g. zero, filter) are restored to their default values.



Loading of the default parameters is irreversible.

Loading the default parameters:

- ① Put the gauge out of operation.
- ② Keep the <ZERO> button depressed for at least 5 s while the gauge is being put into operation (Power ON).

4.7 Diagnostic Port (USB Interface)

The diagnostic port <DIAG> permits to output the pressure reading and all status information and to enter all settings at the same time (→  [4]). A standard USB cable type A/mini B can be used.

Required software: T-Gauge. Please contact your local INFICON service center.

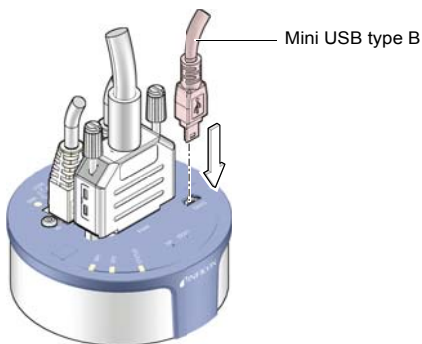

4.8 EtherCAT Operation

Caution

Caution: data transmission errors

Any attempt to simultaneously operate the gauge via the EtherCAT interface and the diagnostic port causes data transmission errors.

Therefore the gauge must not be operated simultaneously via the EtherCAT interface and the diagnostic port.

For operating the gauge via EtherCAT, prior installation of the device specific ESI file is required on the bus master side. This file can be downloaded from our website.

Explicit Device Address Setting (default 00_{hex})

During device initialization, the device address switches are read by the device firmware. This device address is supported to the master as Explicit Device Identification.

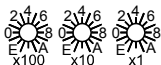

The explicit device address is set in hexadecimal form (00 ... FFF_{hex}) via the <x100>, <x10> and <x1> switches.

Example: Device address = 0xDDD (dec 3549):
 $0x100 * 0xD$ (dec 3328) + $0x10 * 0xD$ (dec 208) + $0x1 * 0xD$ (dec 13)



Status LED

LEDs on the gauge inform on the gauge status and the current EtherCAT status (→ [3]).

5 Deinstallation



WARNING



WARNING: fragile components

The ceramic sensor may be damaged by impacts. Do not drop the product and prevent shocks and impacts.



DANGER



DANGER: contaminated parts

Contaminated parts can be detrimental to health and environment.

Before beginning to work, find out whether any parts are contaminated. Adhere to the relevant regulations and take the necessary precautions when handling contaminated parts.



Caution



Caution: vacuum component

Dirt and damages impair the function of the vacuum component.

When handling vacuum components, take appropriate measures to ensure cleanliness and prevent damages.



Caution



Caution: dirt sensitive area

Touching the product or parts thereof with bare hands increases the desorption rate.

Always wear clean, lint-free gloves and use clean tools when working in this area.

- 1 Vent the vacuum system.
- 2 Put the gauge out of operation.
- 3 Unfasten the lock screws and disconnect the sensor cable.
- 4 Remove the gauge from the vacuum system and install the protective lid.

6 Maintenance, Repair

Under clean operating conditions, the product requires no maintenance.



Gauge failures due to contamination or wear and tear are not covered by the warranty.

We recommend checking the zero at regular intervals (→  24).

INFICON assumes no liability and the warranty becomes null and void if any repair work is carried out by the end-user or third parties.

7 Returning the Product



WARNING



WARNING: forwarding contaminated products

Contaminated products (e.g. radioactive, toxic, caustic or microbiological hazard) can be detrimental to health and environment.

Products returned to INFICON should preferably be free of harmful substances. Adhere to the forwarding regulations of all involved countries and forwarding companies and enclose a duly completed declaration of contamination^{*)}.

^{*)} Form under www.inficon.com

Products that are not clearly declared as "free of harmful substances" are decontaminated at the expense of the customer. Products not accompanied by a duly completed declaration of contamination are returned to the sender at his own expense.

8 Disposal

DANGER



DANGER: contaminated parts

Contaminated parts can be detrimental to health and environment.

Before beginning to work, find out whether any parts are contaminated. Adhere to the relevant regulations and take the necessary precautions when handling contaminated parts.

WARNING



WARNING: substances detrimental to the environment

Products or parts thereof (mechanical and electric components, operating fluids etc.) can be detrimental to the environment.

Dispose of such substances in accordance with the relevant local regulations.

Separating the components

After disassembling the product, separate its components according to the following criteria:

- Contaminated components
Contaminated components (radioactive, toxic, caustic or biological hazard etc.) must be decontaminated in accordance with the relevant national regulations, separated according to their materials, and disposed of.
- Other components
Such components must be separated according to their materials and recycled.

Further Information

- 📖 [1] www.inficon.com
 Operating Manual
 Single-Channel Controller VGC401
 tinb01e1
 INFICON AG, LI-9496 Balzers, Liechtenstein
- 📖 [2] www.inficon.com
 Operating Manual
 Two- & Three-Channel Measurement and Control Unit
 VGC402, VGC403
 tinb07e1
 INFICON AG, LI-9496 Balzers, Liechtenstein
- 📖 [3] www.inficon.com
 Communication Protocol
 EtherCAT CDGxxxDxx
 tira68e1
 INFICON AG, LI-9496 Balzers, Liechtenstein
- 📖 [4] www.inficon.com
 Kommunikationsanleitung
 Diagnostic Port via T-Gauge
 tira84e1
 INFICON AG, LI-9496 Balzers, Liechtenstein
- 📖 [5] ETG.5003.1: Semiconductor Device profile – Part 1:
 Common Device Profile (CDP)
- 📖 [6] ETG.5003.2080: Semiconductor Device profile – Part
 2080: Specific Device Profile (SDP): Vacuum Pressure
 Gauge

EC Declaration of Conformity



We, INFICON, hereby declare that the equipment mentioned below complies with the provisions of the Directive relating to electromagnetic compatibility 2004/108/EC and the Directive on the restriction of the use of certain hazardous substances in electrical and electronic equipment 2011/65/EU.

Product

Capacitance Diaphragm Gauge

Stripe CDG045Dhs

Standards

Harmonized and international/national standards and specifications:

- EN 61000-6-2:2005 (EMC: generic immunity standard)
- EN 61000-6-3:2007 + A1:2011 (EMC: generic emission standard)
- EN 61010-1:2010 (Safety requirements for electrical equipment for measurement, control and laboratory use)
- EN 61326:2013 (EMC requirements for electrical equipment for measurement, control and laboratory use)

Manufacturer / Signatures

INFICON AG, Alte Landstraße 6, LI-9496 Balzers

3 July 2014

3 July 2014



Dr. Urs Wälchli
Managing Director



Hans-Christoph Gehlhar
Product Manager

Notes

Original: German tina84d1 (2014-07)



tina84e1



LI-9496 Balzers
Liechtenstein
Tel +423 / 388 3111
Fax +423 / 388 3700
reachus@inficon.com

www.inficon.com